

Pos.Nr. Pos.no. Position	Beschreibung Description Désignation	Preisgruppe Price bracket Catégorie de prix	Art.-Nr. Art.no. Réf.
1	Motor komplett Motor assembly	85091	57
2	Schraube 2,2 x 9,5 Screw 2,2 x 9,5	85808	2
3	Kardanschale 8 mm Cardan bearing 8 mm	87152	2
4	Platine komplett Printed circuit assembly	87867	43
5	Brückenstecker für DC Connector for DC	100644	7
6	Lichtleitstäbesatz Light transmission bar set	101236	9
7	Motorauflage Motor bearing	101238	3
8	Puffer flach 63691/69691 Buffer flat 63691/69691	106775	3
9	Grundrahmen Frame	107578	30
10	Fenstersatz 63691/69691 Window set 63691/69691	112690	10
11	Teilesatz 3 Parts set 3	112691	18
12	Glühlampe 16 V Light bulb 16 V	109321	10
13	Tank 63691/69691 Tank 63691/69691	112686	2
14	Gehäuse komplett 63691/69691 Body assembly 63691/69691	112687	61
15	Tank 63690/69690 Tank 63690/69690	112725	2
16	Gehäuse komplett 63690/69690 Body assembly 63690/69690	112726	61
17	Dachlüfter 63690/69690 Roof ventilator 63690/69690	112731	2
18	Teilesatz 63690/69690 Parts set 63690/69690	112732	10
19	Puffer 63690/69690 Buffer 63690/69690	112733	2
20	Teilesatz 63690/69690 Parts set 63690/69690	112734	16

**~ Wechselstrom / AC**

21	Dekoder Decoder AC	10738	-
22	Motor komplett Motor assembly	85086	57
23	Platine komplett Printed circuit assembly	87786	43
24	Brückenstecker für AC Connector for AC	100645	7

Symbolische Darstellung  
Symbolic Illustration  
Illustration figurative

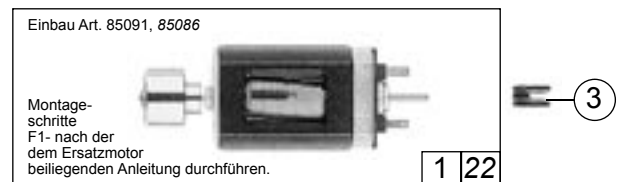
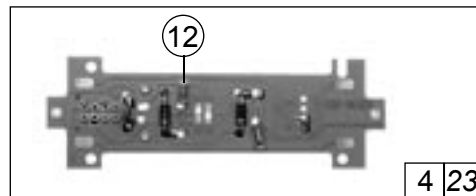
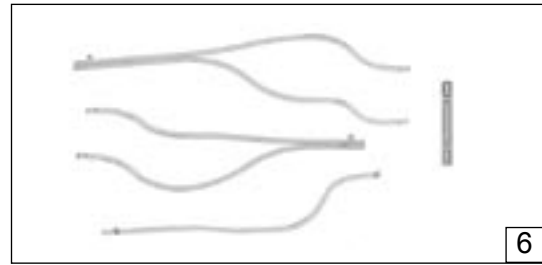
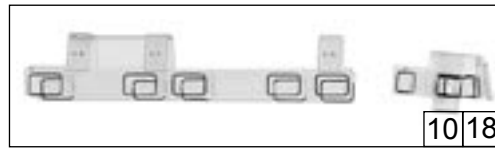
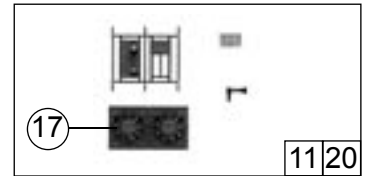

Pos.Nr. Pos.no.	Beschreibung Description Désignation	Preisgruppe Price bracket Catégorie de prix	Art.-Nr. Art.no. Réf.
1	Hafringesatz Set with traction tires	85622	19
2	Zahnrad z=17 / 0,4 G Gear T=17 / 0,4 G	86418	2
3	Schnecken Zahnrad für DC Gear for DC	86419	4
4	Zahnrad Gear	86460	2
5	Zwischenzahnrad Gear	86480	2
6	Schnecke z=1, m 0,6 (DC) Worm z=1, m 0,6 (DC)	86704	5
7	Kardanschale Cardan bearing	87152	2
8	Kupplungskammer Coupling holder	89266	3
9	Universalkupplung Universal coupling	89282	5
10	Lager für Schneckenachse Worm axle bearing	89749	6
11	Radkontakt Wheel current contact	89956	4
12	Teilesatz 2 Parts set 2	101240	11
13	Schneckensatz Worm set	101242	24
14	Getriebebesatz Gear part set	101244	18
15	Radsatz ohne Hafring Wheel without traction tyre	107581	18
16	Radsatz mit 2 Hafringen Wheelset with 2 traction tires	107582	20
17	Deckel DC Cover DC	107585	5
18	Kontakthalter Contact holder	107586	5
19	Leiter Step	107589	3
20	Schneckendeckel mit Stabilisatorfeder Worm cover with vibration damper	107991	8
21	Zurüstbeutel 63691/69691 Bag with accessories 63691/69691	112688	32
22	Teilesatz 1 Part set 1	112689	24
23	Zurüstbeutel 63690/69690 Bag with accessories 63690/69690	112727	32
24	Teilesatz für 63690/69690 Part set for 63690/69690	112728	20
25	Teilesatz für 63690/69690 Part set for 63690/69690	112729	7
26	Laufblech 63690/69690 Runway 63690/69690	112730	2
<b>~ Wechselstrom / AC</b>			
27	Flüsterschleifer Whisper wiper	40064	-
28	Hafringesatz Set with traction tires	85623	16
29	Schnecken Zahnrad für ~ Gear for ~	86413	4
30	Schnecke für ~ Worm for ~	86702	5
31	Radsatz ohne Zahnrad Wheelset without gear	90895	16
32	Radsatz mit 2 Hafringen Wheelset with 2 traction tires	90896	20
33	Radsatz ohne Hafring mit Zahnrad Wheel without traction tyre with gear	90917	18
34	Schneckensatz Worm set	101253	24
35	Getriebe Gear	101255	12
36	Deckel ~ Cover ~	107592	8
37	Schraube 1,6 x 5 Screw 1,6 x 5	110008	2

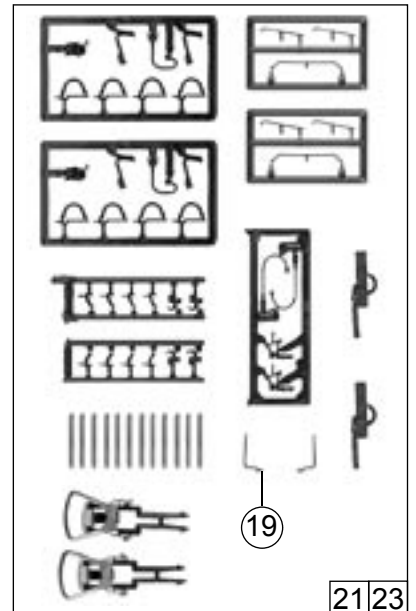
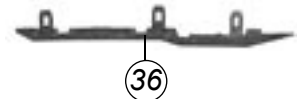
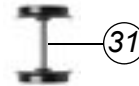
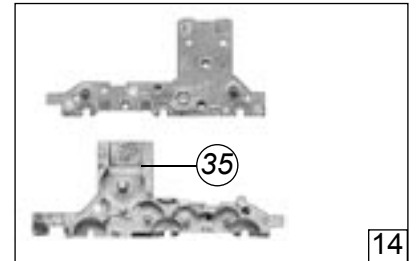
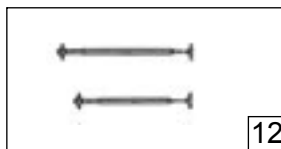
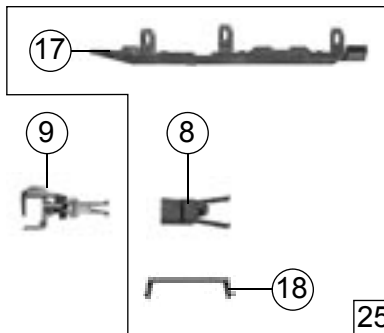
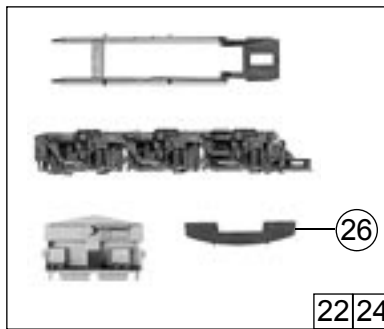
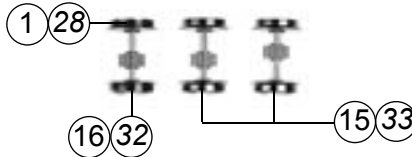
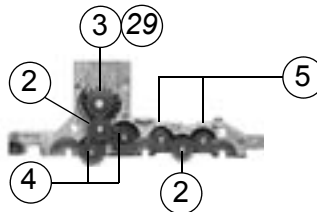
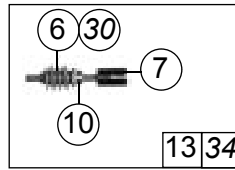
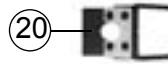

Ersatzteile erhalten Sie bei Ihrem Fachhändler, Ihrer Landesvertretung, oder bei:  
*You can order your Replacement Parts at your local dealer, your country representative, or:*  
 Passez commande des pièces détachées chez votre détaillant, chez le S.A.V. de votre importateur national ou en direct au S.A.V.  
 ROCO:

**ROCO Modellsportwaren**  
**VertriebsgmbH & Co. Handels KG**  
 - Service -  
**Georg-Wrede-Straße 49**  
**D 83395 Freilassing**  
 ☎ +49 / (0)86 54 / 47 63 0  
 Fax: +49 / (0)86 54 / 47 63 50  
 E-Mail: [service@roco-online.de](mailto:service@roco-online.de)